

A14 Planfräser *Face mills, Fraises à surfacer, Frese a spianare*

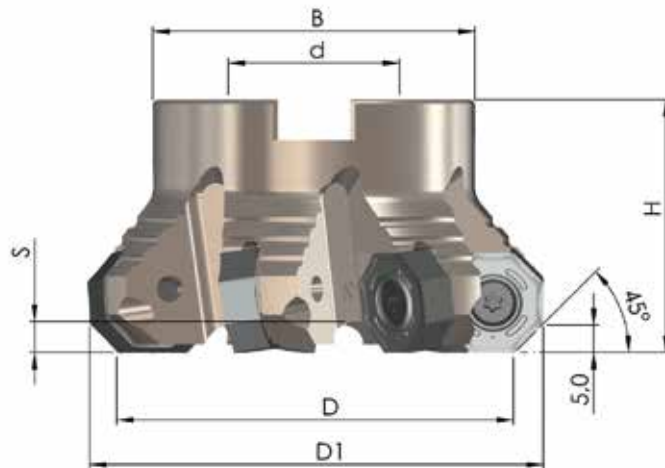

Aufsteckfräser *Shell type mills, Fraises à alésage, Frese per attacco a manicotto*









Bestell-Nr. <i>Order-No., Référence, Codice</i>	D	D ₁	H	d	B	S	Z	MS
45PP-050-558-4	50	62,8	50	22	46	3,5	4	MS-10x35-912
45PP-063-558-5	63	75,8	50	27	58	6,0	5	MS-12x30-912
45PP-080-558-6	80	92,8	50	32	78	6,0	6	MS-16x30-6912
45PP-100-558-7	100	112,8	50	32	78	1,5	7	MS-16x30-912
45PP-125-558-9	125	137,8	63	40	90	5,5	9	MS-20x55-7991
45PP-160-558-11	160	172,8	63	40	90	5,5	11	MS-20x55-7991
Enge Teilung <i>close pitch, à pas réduit, a passo stretto:</i>								
45PP-080-558-7	80	92,8	50	32	78	6,0	7	MS-16x30-6912
45PP-100-558-9	100	112,8	50	32	78	1,5	9	MS-16x30-912
45PP-125-558-11	125	137,8	63	40	90	5,5	11	MS-20x55-7991
45PP-160-558-13	160	172,8	63	40	90	5,5	13	MS-20x55-7991

MS= Mittenschraube *Central screw, Vis centrale, Vite centrale di fissaggio*

A14 Fräswendepplatten und Schnittdaten

Milling inserts and parameters, Plaquettes de fraisage et paramètres, Inserti e parametri di taglio

			HT45 (code 31)	HT50 (code 22)	HT32 (code 33)	HT20 (code 32)	KT28 (code 23)		
	JMA14-458- IK 20,0 x 7,64	Order- No.	A14A-DL31		A14A-CK33	A14A-BB32			
		f_z [mm]	0,25 (0,20-0,50)		0,25 (0,20-0,50)	0,25 (0,20-0,50)			
	JMA14-558- IK 20,0 x 7,64	Order- No.	A14A-EO31	A14A-FP22			A14A-GS23		
		f_z [mm]	0,25 (0,20-0,50)	0,25 (0,20-0,50)			0,25 (0,20-0,50)		
	JMA14-858- IK 20,0 x 7,64	Order- No.	A14B-EW31		A14B-DU33	A14B-CT32			
		f_z [mm]	0,25 (0,20-0,50)		0,25 (0,20-0,50)	0,25 (0,20-0,50)			
			10	10	10	10	10		

V_c [m/min]	Stahl Steel Acier Acciaio	Rostfrei Stainless Acier inoxydable Inossidabile	Guss Cast iron Fonte Ghisa	NE-Metalle Non-ferrous metals Non ferreux Metalli non ferritici	Hochwarmfest Highly heat-resistant Superalliages Resistente al calore	Gehärtet Tempered Aciers traités Temprato
HT45	250 (200 - 350)	240 (140 - 300)	240 (130 - 280)			
HT50	220 (160 - 300)	200 (100 - 300)	260 (200 - 300)			
HT32	250 (200 - 350)	240 (140 - 300)			60 (40 - 200)	
HT20			260 (180 - 350)			80 (40 - 120)
KT28			260 (180 - 350)			80 (40 - 120)

Ersatzteile Spare parts, Pièces de rechange, Parti di ricambio

	SS 6,0-1 (M = 5,6-5,8 Nm)		T 25		Fett Grease, Graisse, Grasso
---	-------------------------------------	---	-------------	---	--